

TROOP 780 - DUNN, NC

Lashing

Lashing Skills



[Square](#) | [Diagonal](#) | [Tripod](#) | [Japanese Square](#) | [Filipino Diagonal](#) | [Round](#) | [Shear](#) | [Ladder](#)

Square Lashing - Step by Step

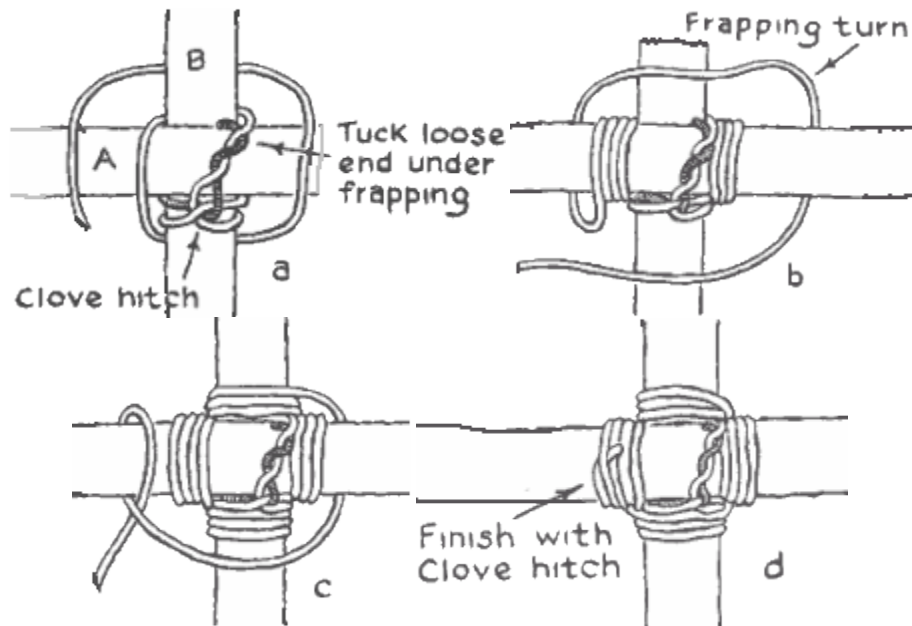

- Used to fasten two spars or poles together.
- Start by crossing the two sticks or dowels at perpendicular or 90 degree angles.
- Make a [Clove Hitch](#) on the vertical stick or dowel near the point where the two sticks cross. This fastens the rope to the stick.
- Weave the rope under and over the crossed sticks alternately.
- To do this, run the rope over the horizontal bar, around behind the vertical bar, then back over the face of the horizontal bar on the left.
- Tighten snugly, and then bring the rope behind the vertical bar and up the right front side of the horizontal bar.
- Repeat this three or four times, keeping the rope tight.
- When you have finished weaving the lashing, then "FRAP" it by wrapping the rope between the poles (in front of the back stick and in back of the front stick), pulling tightly. This tightens the connected poles.
- Finish your lashing with another [Clove Hitch](#).

Diagonal Lashing - Step By Step

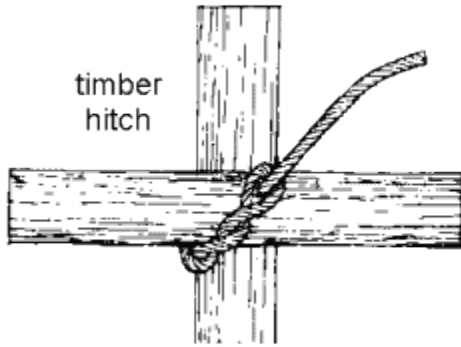

Step 1

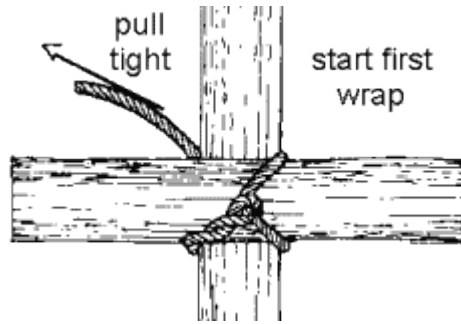

Step 2

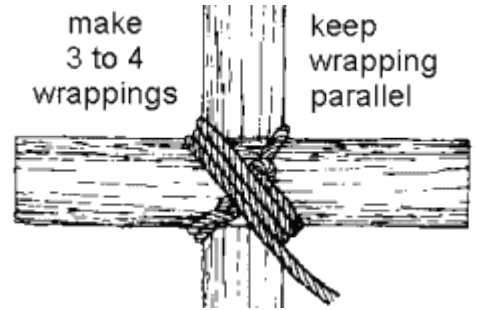

Step 3

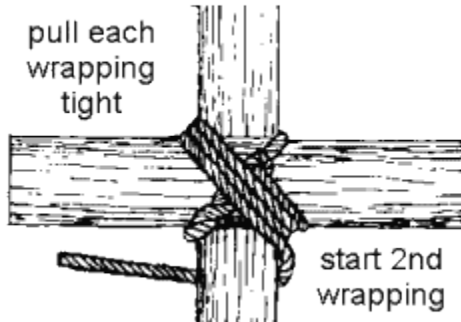

Step 4

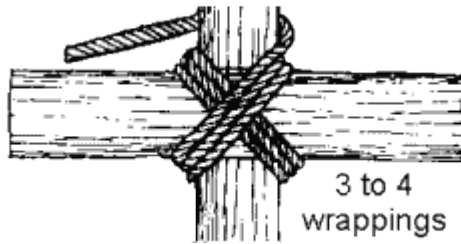

Step 5

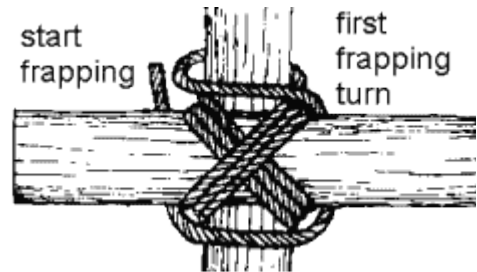

Step 6

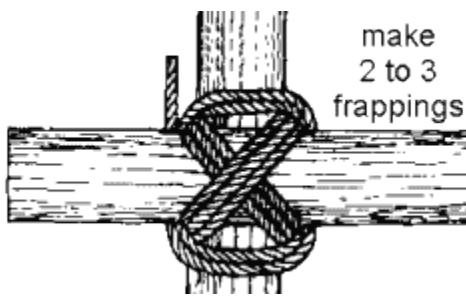

Step 7

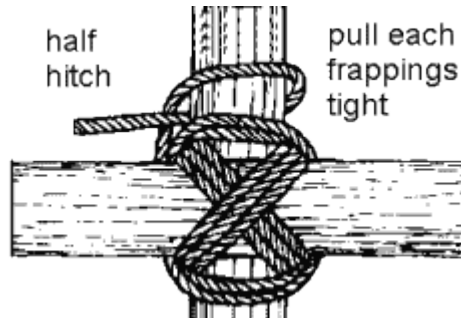

Step 8

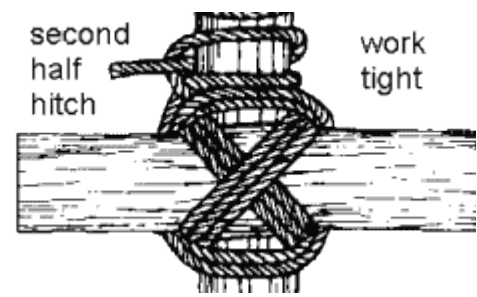

Step 9

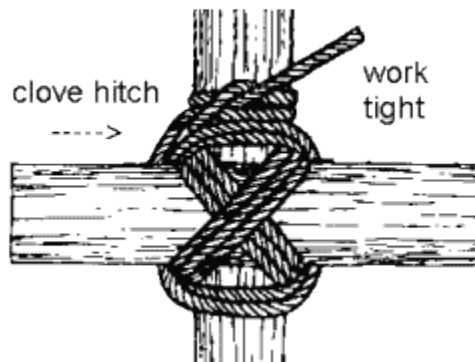

Step 10

Use

Diagonal lashing is used to bind poles together that cross each other but do not touch when their ends are lashed in place in a structure.

Comments

The diagonal lashing gets its name from the fact that the wrapping turns cross the poles diagonally. The diagonal lashing can be used to bind poles that cross each other from 90° to 45°. If the angle between the poles is less than 45° a shear lashing should be used. The diagonal lashing makes use of the timber hitch to pull poles together that are not touching each other. The [timber hitch](#) allows the poles to be drawn together without changing the relative positions of the poles. [NOTE] If a square lashing were used to bind poles that do not touch, the beginning clove hitch would pull the cross pole toward the clove hitch causing unnecessary bowing of the cross pole and could also produce a force that would act along the length of the pole to which the clove hitch is tied. These additional forces, if strong enough, can place unnecessary strain on other lashing within the structure causing the structure to twist and fail.

Narration

1. Tie a timber hitch diagonally around both poles.
2. Start the wrapping turns on the opposite diagonal to the timber hitch, by pulling the rope tight so that the poles contact each other.
3. Take 3 to 4 wrapping turns; keep the wrapping turns parallel; pull each wrapping turn tight. [NOTE] If the wrapping turns are allowed to cross, the increased friction between the strands of the rope will make it difficult to tighten the wrapping turns.
4. Start the second set of wrapping turns by going past and around the vertical pole. [NOTE] Going around the pole the rope allows the direction of the rope to be changed without crossing the first set of wrapping diagonally.
5. Take 3 to 4 wrapping turns; be sure to keep the wrapping turns parallel; pull each wrapping turn tight.
6. Start the frapping turns by going past and around one of the poles. [NOTE] Going around the pole with the rope allows the direction of the rope to be changed without crossing the wrapping turns diagonally.
7. Take 2 to 3 frapping turns; keep the frapping turns parallel. Be sure to pull each turn tight.
8. End the lashing with a clove hitch. Take the first half hitch of the clove hitch by going past and then around one of the poles. Lock the half hitch tight against the lashing by working it tight.
9. Take a second half hitch around the pole.
10. Work the second half hitch tight against the first half hitch so that the clove hitch is locked against the lashing.

If very smooth rope is used, the lashing can be made more secure by adding a third or fourth half hitch to the clove hitch.

Tripod Lashing - Step By Step

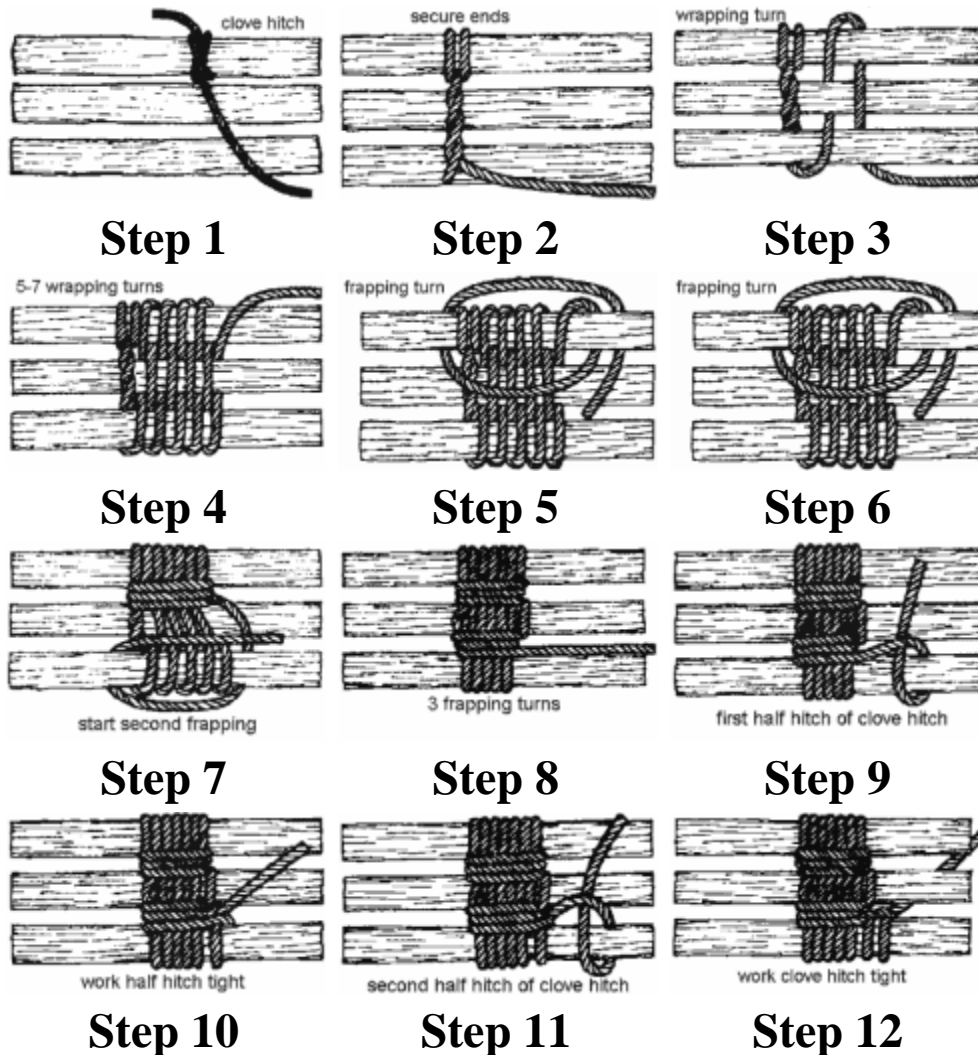

Description

A shear lashing around 3 poles.

Use

To bind three poles together, for the construction of a tripod. To bind three poles together that contact at the same point in a structure.

Comments

The tripod lashing is a shear lashing that binds three poles together at the same point. The tripod lashing gets its name from the fact that its most common use is the construction of a tripod. The tripod lashing can be used just about anywhere in a structure that three poles cross each other at the same point and the same time in the sequence of construction. Tripod lashing takes two main forms; with racked wrapping turns (the rope is woven between the poles) and with plain wrapping turns (the rope is wrapped around the poles without weaving the rope between the poles). When the lashing is made with racking turns the rope contacts each pole around its entire circumference; this contact makes the tripod lashing with racking turns the most secure form of tripod lashing: therefore tripod lashing

with racking turns should be used when safety is important. However, for light structures where there would be no danger if the lashing slipped, the faster to tie tripod lashing with plain wrapping turns may be used

Laying Out The Poles



For most tripod lashings, lay the pole side by side with the butt ends aligned. The alignment of the butts of the pole insures that the tripod legs are the desired length

Note

The practice of laying the center pole in the opposite direction to the outside poles creates several problems. When the poles are laid in opposite directions the wrappings must be put on loosely so that when the center pole is rotated to its proper position the lashing is tightened around the poles. If the wrappings are put on too tight, the rope is stretched causing damage to the rope fibers, therefore weakening the lashing. On the other hand, if the rope is wrapped too loosely, the lashing will not tighten enough when the center pole is rotated and the lashing will be able to slip along the length of the pole. Either way, the rope too loose or the rope too tight, a dangerous situation is created.

Setting Up A Tripod

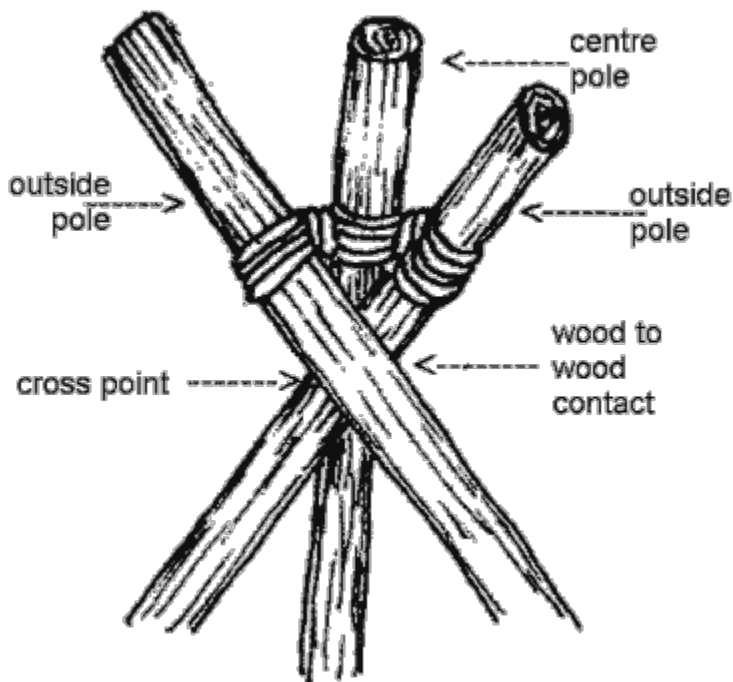

Set up the tripod by crossing the outside poles so that the cross point of the poles is under the center pole. Crossing the outside poles under the center pole causes part of the load that is placed on the tripod to be taken up by the wood to wood contact of the poles.

Japanese Square Lashing - Step By Step

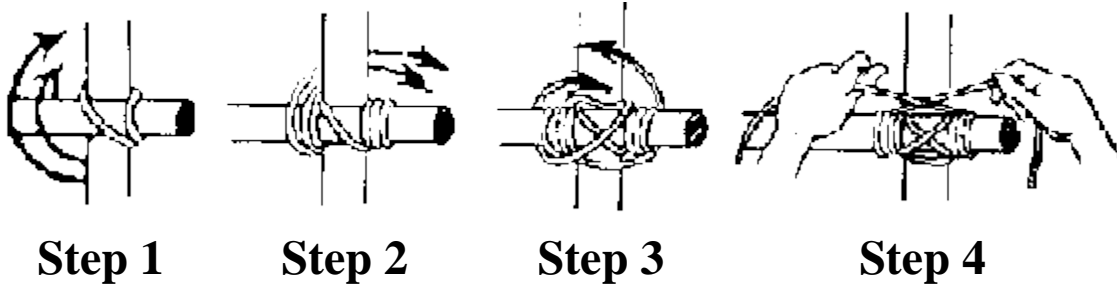

Comments

- A lashing used in lightweight construction work.
- It is equivalent to a Square Lashing and when done correctly should be just as strong.
- Much quicker to do than a Square Lashing.
- The knot is finished off with a Square Knot.
- A shear lashing around 3 poles.

Filipino Diagonal Lashing - Step By Step

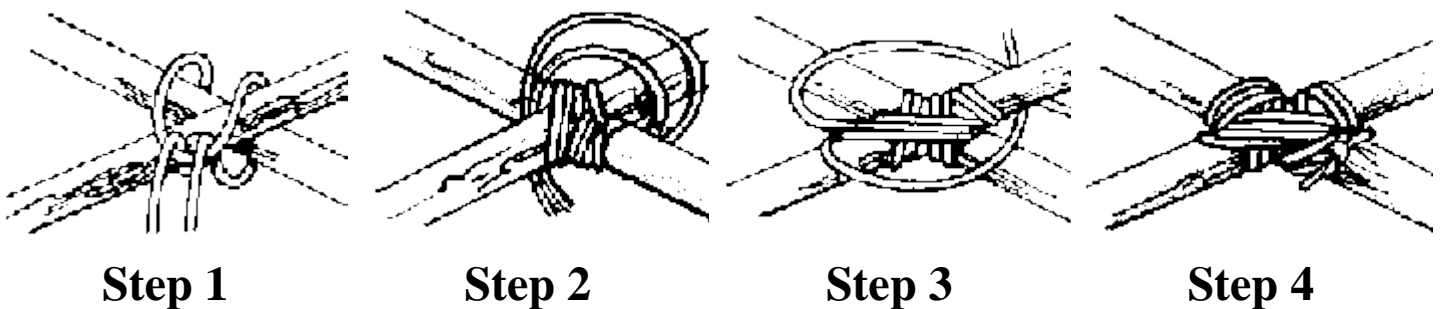

1. A lashing used in lightweight construction work.
2. Start with the middle of the rope, tucking the running ends through the middle "loop" after going round both spars. Use the "loop" to pull the spars together.
3. Now proceed as for a diagonal lashing taking the running end round both spars, keeping both ends together.
4. Separate the ends and take frapping turns between the spars, pulling the rope tight as you do so.
5. Complete the frapping turns and finish off with a reef (square) knot.

Round Lashing - Step By Step

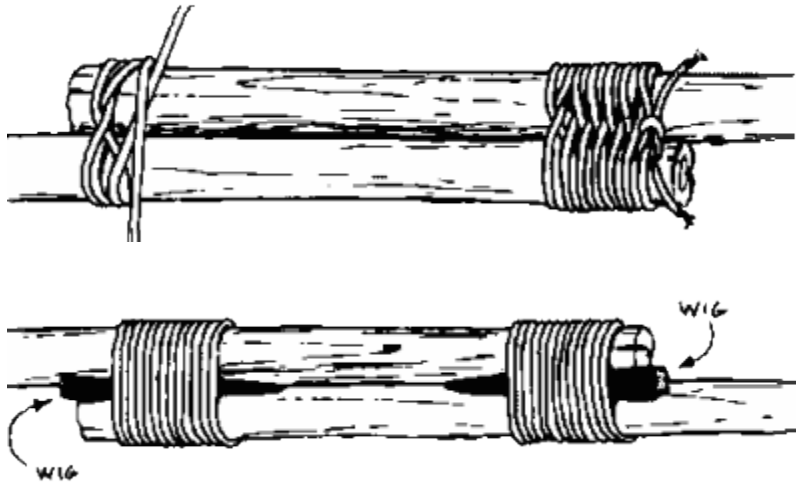

Comments

1. Used to lash two poles together (constructing a flagpole).
2. Tie a clove hitch round the bottom pole.
3. Wind the rope around both six or seven times.
4. Finish with two half hitches round both poles.
5. The lashing can be tightened by driving a small wooden peg between the poles.
6. If possible force a wedge under the lashings to make them really tight. If the spars are vertical, bang the wedge in downwards.

[- Top -](#)

Shear Lashing

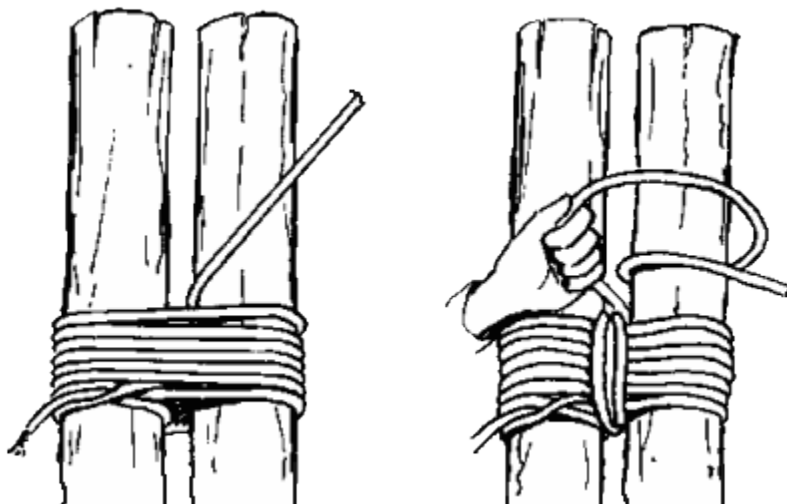



Comments

A sheer lashing is often used to bind adjacent poles together. It is also a good way to reinforce a broken or weak pole. The frapping turns used to tighten the lashing may be omitted and replaced with wedges inserted between the poles.

A loose Sheer Lashing made around the ends of two poles will allow the poles to be opened out and used as an A-frame. It can also be used to form a tripod just like the Figure-of-eight lashing.

1. Lay out the poles. For most lashings you will want to lay the poles side by side with the butt ends aligned (thicker ends).
2. Tie a clove hitch around one of the outside poles and secure the standing part by wrapping it around the running part (or trap it under the first turns). Note: If you only lashing two poles together it may be better to simply tie the clove hitch around both poles and pull tight.
3. Pass the rope around the poles to form a first turn.
4. Pulling each turn tight made a series of turns until the lashing is at least as long as the combined diameters of the two poles (usually a set of 4 to 6 turns will be sufficient).
5. Tighten the lashing with a frapping turn by taking the rope down between two poles at one end of the turns. This should be difficult to do if the turns have been pulled tightly (as they should be). Bring the rope back up between the poles at the other end of the lashing and pull tight. Repeat 2 or 3 times.
6. Start the second set of frapping turns by taking the rope around the center pole and frapping. Take the second set of frapping turns in the opposite direction to the first set.
7. Repeat for any additional poles.
8. Pass the rope once more between the poles then around one pole and tuck it under itself to form a half hitch. Pull this tight and make a second half hitch forming a clove hitch by taking the rope around the same pole and tucking it under itself.

Notes on A-Frame Lashing

An A-frame lashing or Sheer Legs is made in the same way as a Sheer Lashing with the lashing and frapping turns made slightly loose so that the poles can be opened out. It is often used to raise a boat mast or to form the legs of a rope bridge. You must take care to ensure that the legs of the frame do not slip.

Notes on Tripods

Take a tripod by using a Figure-of-eight lashing on three poles. Set up the tripod by crossing the outside poles so that the cross point of the poles is under the center pole. This makes sure that part of the load is taken by the wood in contact.

If a symmetrical arrangement of the poles is needed within a structure the tripod can be set up by rotating the poles around the lashing. This means that the load is supported only by the ropes and the joint becomes flexible and so the tripod may become unstable.

Ladder Lashing

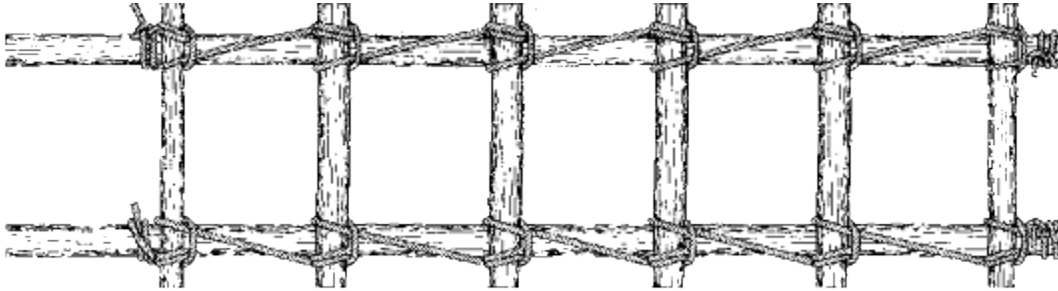

Comment

Ladder lashing allows for a quick and secure method for constructing a ladder or for constructing a decking with evenly spaced decking pieces.

This form of lashing has several advantages over the traditional floor lashing. Less material is required because unlike floor lashing a space can be left between each piece of the decking. Also, each rung is securely lashed in place by several loops of rope in much the same way as a square lashing; with the traditional floor lashing only a single loop of the rope holds each end of the decking in place, therefore if one piece loosens, the entire deck loosens.

The ladder lashing has two forms; left and right, each is a mirror image of the other.

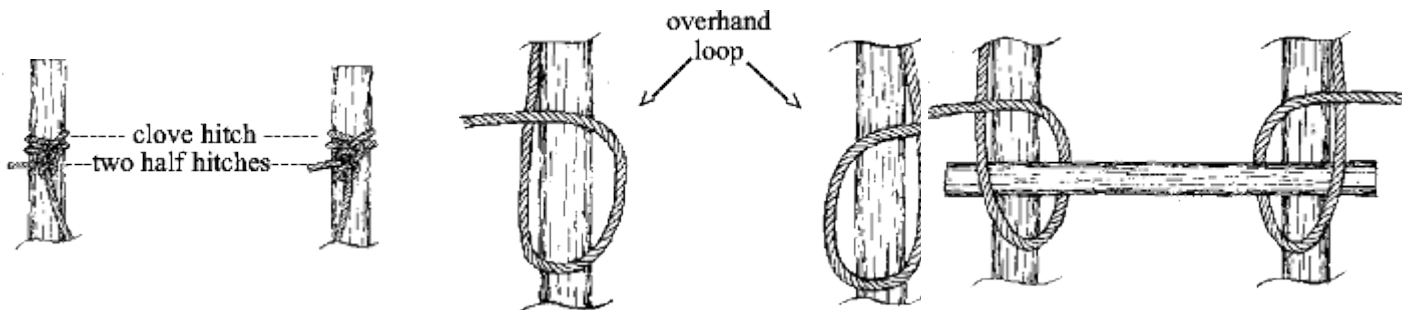

Step 1: The ladder lashing is started by using a clove hitch stopped with two half hitches to secure a rope to the top end of each rail.

Step 2: Lay an overhand loop over each side rail so that the running end of each loop is to the outside.

Step 3: Place a rung across the rails so that the standing part of each overhand loop is over the end of the rung and the running part of each overhand loop is under the rung.

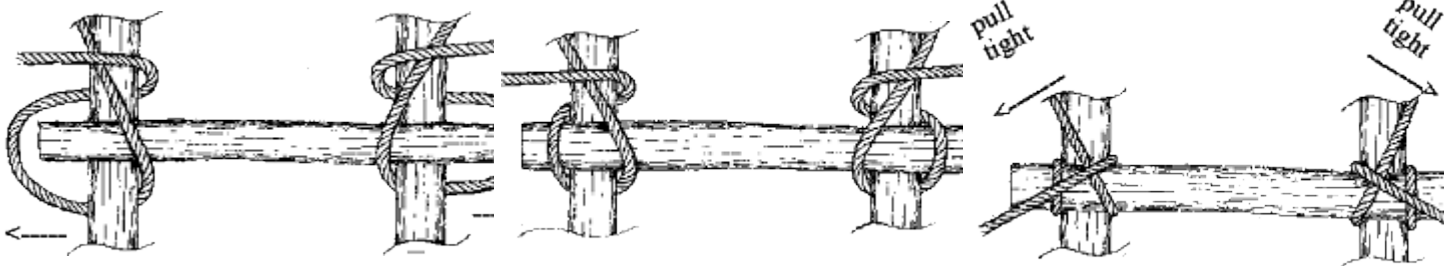

Step 4: Pull the running part side of each overhand loop behind and to the outside of each rail.

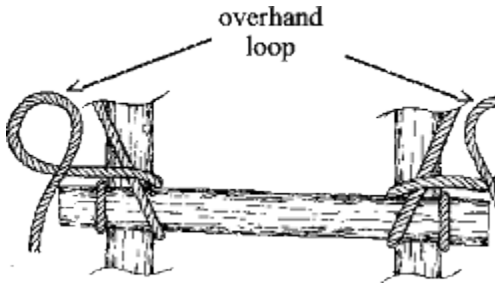

Step 5: Then pull the loop over the end of the rung.



Step 6: Work each rope until it is tightened around the rung and the rung is in its desired position.

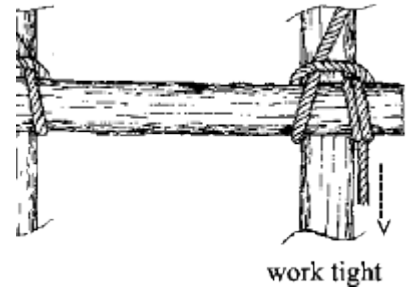

Step 7: Form an overhand loop in each running part.

Step 8: Place an overhand loop over each end of the rung to form a half hitch around each end of the rung.

Step 9: Work the half hitch tight

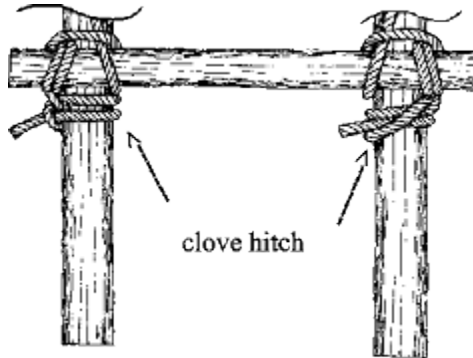

Step 10: Repeat steps 1 through 8 for each additional rung.

END: Finish the lashing by tying a clove hitch around each rail so that the clove hitch is directly under the bottom rung.

[- Top -](#)
